

Type	Omschrijving	Pagina
CB5-S4	Kogelkopscharnier RVS 304	45
CB6-S3	Gaffel met pen RVS 303	45
CB7-S4	Grondplaatbevestiging RVS 304	45
CB9-S4	Montageflens RVS 304	46
CB1-S4	Achter/contrascharnier RVS 304	46

Type	Omschrijving	Pagina
CB2-S4	Achterscharnier inclusief pen RVS 304	46
CB3-S4	Contrascharnier RVS 304	47
CB10-S6	Achter/contrascharnier RVS 316	47
CB12-S6	Achterscharnier inclusief pen RVS 316	47

Any questions? Please contact us.

Morskate Aandrijvingen BV
 Oosterveldsingel 47A
 7558 PJ Hengelo (Ov)
 The Netherlands

NL
 T +31 (0)74 - 760 11 11
 info@morskateaanrijvingen.nl
 www.morskateaanrijvingen.nl

DE
 T +49 692 - 222 34 95
 info@morskateantriebstechnik.de
 www.morskateantriebstechnik.de

EN
 T +31 (0)74 - 760 11 11
 info@morskatedrivetechnology.com
 www.morskatedrivetechnology.com



cilinders

hand- en mechanisch bediende ventielen

elektrisch bediende ventielen

luchtbediende ventielen

magneetventielen

luchtbediende schuine klepafsluiters

luchtverzorging

hulpventielen

aansluitmateriaal

CB5-S4 kogelkopscharnier

RVS 304

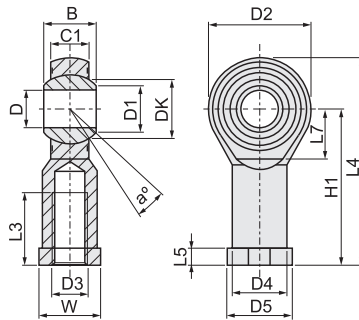

Ø	Type	Artikelnr.	a°	B	C1	D1	D2	D3	D4	D5	DK	D	H1	L3	L4	L5	L7	W
32	CB5-S4-M10x1,25	PI32023	13	14	10,5	12,9	28	M10x1,25	15	19	19,05	10	43	20	57	6,5	15	17
40	CB5-S4-M12x1,25	PI32024	13	16	12	15,4	32	M12x1,25	17,5	22	22,22	12	50	22	66	6,5	17	19
50/63	CB5-S4-M16x1,5	PI32025	15	21	15	19,3	42	M16x1,5	22	27	28,57	16	64	28	85	8	23	22
80/100	CB5-S4-M20x1,5	PI32026	14	25	18	24,3	50	M20x1,5	27,5	34	34,92	20	77	33	102	10	27	30

CB6-S3 gaffel met pen

RVS 303

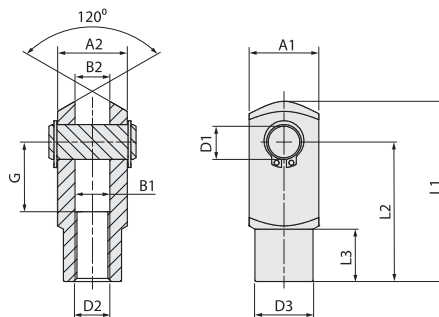

Ø	Type	Artikelnr.	A1	A2	B1	B2	G	L1	L2	L3	D1	D2	D3
32	CB6-S3-M10x1,25	PI32030	20	20	10	10	20	52	40	15	10	M10x1,25	18
40	CB6-S3-M12x1,25	PI32031	24	24	12	12	24	62	48	18	12	M12x1,25	20
50/63	CB6-S3-M16x1,5	PI32032	32	32	16	16	32	83	64	24	16	M16x1,5	26
80/100	CB6-S3-M20x1,5	PI32033	40	40	20	20	40	105	80	30	20	M20x1,5	34

CB7-S4 grondplaatbevestiging

RVS 304

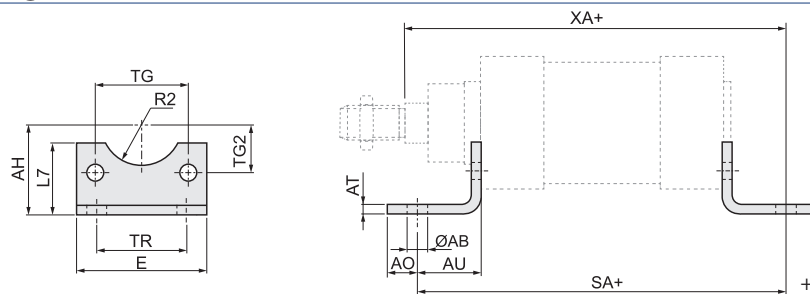

Ø	Type	Artikelnr.	AB	AH	AO	AT	AU	E	L7	R2	SA+	TG2	TG	TR	XA+
32	CB7-S4-32	PI32035	7	32	11	4	24	45	30	15	142	16,25	32,5	32	144
40	CB7-S4-40	PI32036	10	36	8	4	28	52	30	17,5	161	19	38	36	163
50	CB7-S4-50	PI32037	10	45	15	5	32	65	36	20	170	23,25	46,5	45	175
63	CB7-S4-63	PI32038	10	50	13	5	32	75	35	22,5	185	28,25	56,5	50	190
80	CB7-S4-80	PI32039	12	63	14	6	41	95	47	22,5	210	36	72	63	215
100	CB7-S4-100	PI32040	14,5	71	16	6	41	115	53	27,5	220	44,5	89	75	230



CB9-S4 montageflens

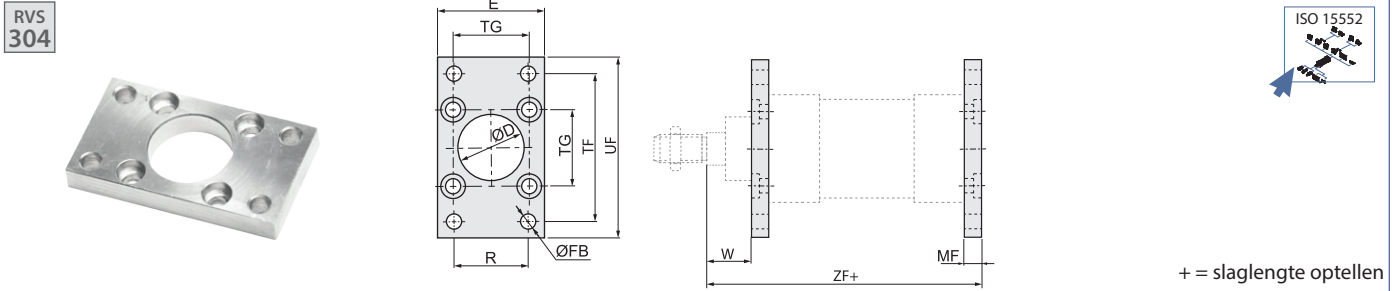

Ø	Type	Artikelnr.	E	MF	D	FB	R	TF	TG	UF	W	ZF+
32	CB9-S4-32	PI32049	45	10	30	7	32	64	32,5	80	16	130
40	CB9-S4-40	PI32050	52	10	35	9	36	72	38	90	18,7	145
50	CB9-S4-50	PI32051	65	12	40	9	45	90	46,5	110	23,6	155
63	CB9-S4-63	PI32052	75	12	45	9	50	100	56,5	120	23,9	170
80	CB9-S4-80	PI32053	95	16	45	12	63	126	72	150	29,4	190
100	CB9-S4-100	PI32054	115	16	55	14	75	150	89	170	33,3	205

CB1-S4 Achter/contrascharnier

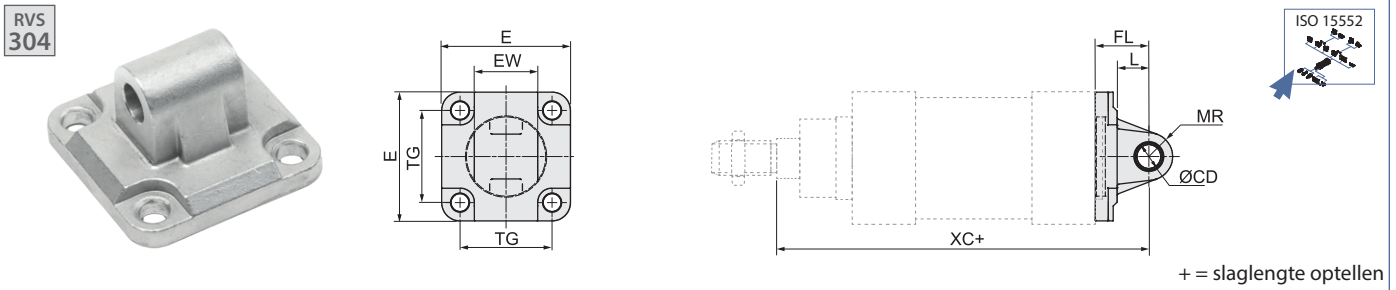

Ø	Type	Artikelnr.	EW	E	FL	L	MR	CD	TG	XC+
32	CB1-S4-32	PI32000	26	45	22	13	10	10	32,5	142
40	CB1-S4-40	PI32001	28	52	25	16	12	12	38	160
50	CB1-S4-50	PI32002	32	65	27	16	12	12	46,5	170
63	CB1-S4-63	PI32003	40	75	32	21	16	16	56,5	190
80	CB1-S4-80	PI32004	50	93	36	22	16	16	72	210
100	CB1-S4-100	PI32005	60	110	41	27	20	20	89	230

CB2-S4 achterscharnier (incl. pen)

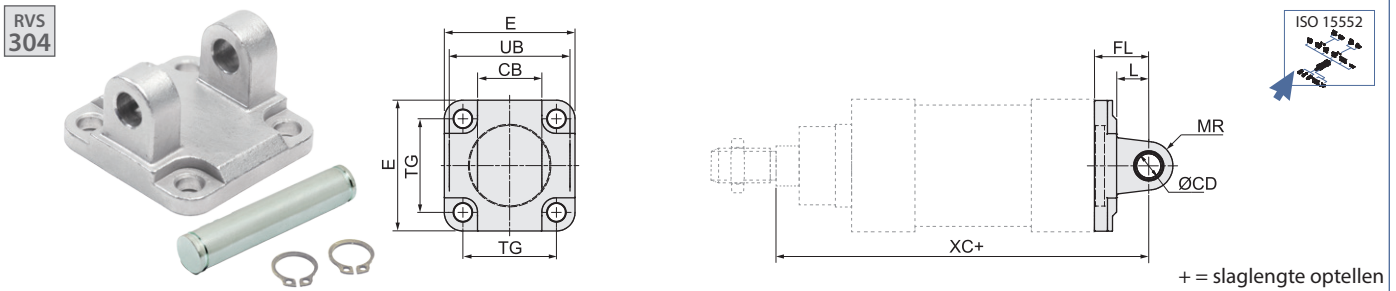

Ø	Type	Artikelnr.	CB	E	FL	L	MR	CD	TG	UB	XC+
32	CB2-S4-32	PI32007	26	45	22	13	10	10	32,5	45	142
40	CB2-S4-40	PI32008	28	52	25	16	12	12	38	52	160
50	CB2-S4-50	PI32009	32	65	27	16	12	12	46,5	60	170
63	CB2-S4-63	PI32010	40	75	32	21	16	16	56,5	70	190
80	CB2-S4-80	PI32011	50	93	36	22	16	16	72	90	210
100	CB2-S4-100	PI32012	60	110	41	27	20	20	89	110	230

CB3-S4 contrascharnier

RVS 304

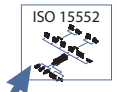
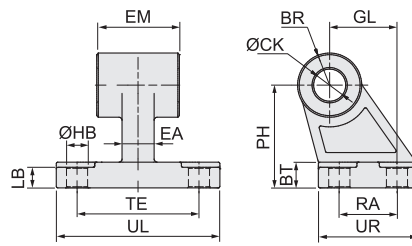

Ø	Type	Artikelnr.	BR	BT	CK	EA	EM	GL	LB	HB	PH	RA	TE	UL	UR
32	CB3-S4-32	PI32014	10	8	10	10	26	21	6,4	6,6	32	18	38	51	31
40	CB3-S4-40	PI32015	11	10	12	15	28	24	8,4	6,6	36	22	41	54	35
50	CB3-S4-50	PI32016	13	12	12	16	32	33	10,4	9	45	30	50	65	45
63	CB3-S4-63	PI32017	15	14	16	16	40	37	12,4	9	50	35	52	67	50
80	CB3-S4-80	PI32018	15	14	16	20	50	47	11,5	11	63	40	66	86	60
100	CB3-S4-100	PI32019	19	17	20	20	60	55	14,5	11	71	50	76	96	70

CB12-S6 achterscharnier (incl. pen)

RVS 316

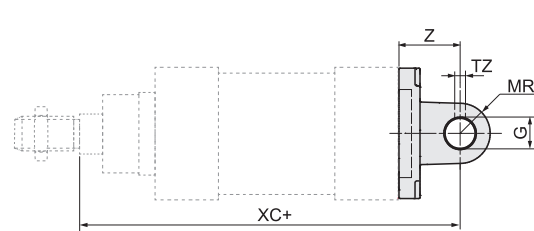
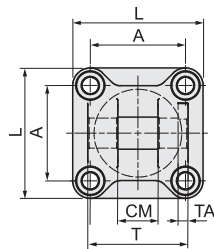

+ = slaglengte optellen

Ø	Type	Artikelnr.	A	CM	G	L	MR	TA	TZ	T	Z	XC+
32	CB12-S6-32	PI32063	32,5	14	10	45	10	3	3,3	34	22	142
40	CB12-S6-40	PI32064	38	16	12	52	12	4	4,3	40	25	160
50	CB12-S6-50	PI32065	46,5	21	16	65	14	4	4,3	45	27	170
63	CB12-S6-63	PI32066	56,5	21	16	75	18	4	4,3	51	32	190
80	CB12-S6-80	PI32067	72	25	20	95	20	4	4,3	65	36	210
100	CB12-S6-100	PI32068	89	25	20	115	22	4	6,3	75	41	230

CB10-S6 Achter/contrascharnier

RVS 316

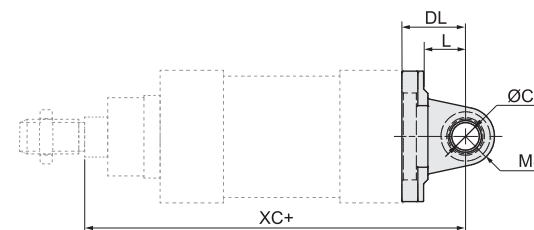
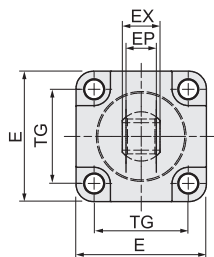

+ = slaglengte optellen

Ø	Type	Artikelnr.	DL	EP	EX	E	L	MS	CX	TG	XC+
32	CB10-S6-32	PI32056	22	10,5	14	45	12	16	10	32,5	142
40	CB10-S6-40	PI32057	25	12	16	52	15	18	12	38	160
50	CB10-S6-50	PI32058	27	15	21	65	15	21	16	46,5	170
63	CB10-S6-63	PI32059	32	15	21	75	20	23	16	56,5	190
80	CB10-S6-80	PI32060	36	18	25	95	20	28	20	72	210
100	CB10-S6-100	PI32061	41	18	25	115	25	30	20	89	230



cilinders
hand- en mechanisch bediende ventielen
elektrisch bediende ventielen
luchtbediende ventielen
magneetventielen
luchtbediende schuine klepafsluiters
luchtverzorging
hulpventielen
aansluitmateriaal

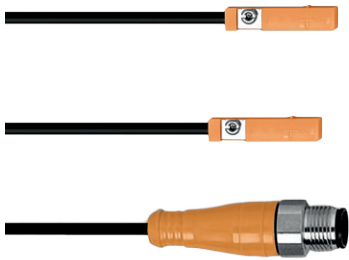

Specificaties S3 naderingsschakelaars

	S3-P-6M	S3-P-M12
Werking	elektronisch	
Elektrische aansluiting	kabel 3-aderig	kabel met M12x1 stekker
Schakelfunctie	PNP normaal open	
Spanning	10-30 VDC	
Max. uitgangsstroom	100 mA	
Schakelweergave	gele LED	
Kabelkleur	zwart	
Kabelmateriaal	PVC	
Kabellengte	6 mtr	0,3 mtr
Beschermingsgraad	IP 65/IP 67/IP 69K, III	

Artikelnummers S3 naderingsschakelaars en montagebeugels

Type	Artikelnr.	Omschrijving	
S3-P-6M	PI30295	S3-P-6M (WET AREA) PNP naderingsschakelaar	
S3-P-M12	PI30296	S3-P-M12 (WET AREA) PNP naderingsschakelaar	
CK-2M-M12	PI30288	CK-2M-M12 Connector kabel lengte 2 meter t.b.v. M12	
CK-5M-M12	PI30289	CK-5M-M12 Connector kabel lengte 5 meter t.b.v. M12	
SM7-S6-32/40	PI32090	SM7-S6-32/40 RVS316 sensor montagebeugel t.b.v. RDWIC Ø 32 en Ø 40 mm	
SM7-S6-50/63	PI32091	SM7-S6-50/63 RVS316 sensor montagebeugel t.b.v. RDWIC Ø 50 en Ø 63 mm	
SM7-S6-80/100	PI32092	SM7-S6-80/100 RVS316 sensor montagebeugel t.b.v. RDWIC Ø 80 en Ø 100 mm	

Any questions? Please contact us.

Morskate Aandrijvingen BV
Oosterveldsingel 47A
7558 PJ Hengelo (Ov)
The Netherlands

NL
T +31 (0)74 - 760 11 11
info@morskateaanrijvingen.nl
www.morskateaanrijvingen.nl

DE
T +49 692 - 222 34 95
info@morskateantriebstechnik.de
www.morskateantriebstechnik.de

EN
T +31 (0)74 - 760 11 11
info@morskatedrivetechnology.com
www.morskatedrivetechnology.com



Afmetingen S3 naderingsschakelaars en SM7 montagebeugels

S3-P-6M

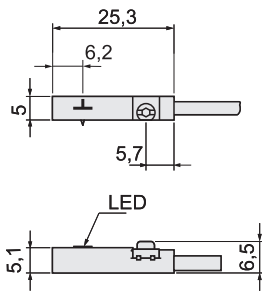

S3-P-M812

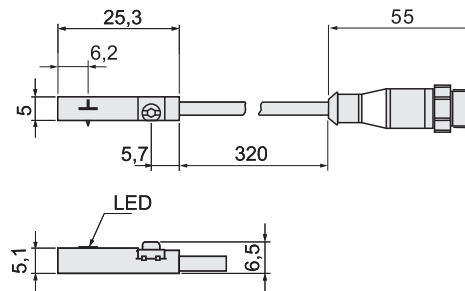

montagebeugels

RVS
316

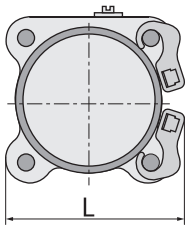

Ø	L	Ø	L
32	51	63	79
40	57	80	98
50	67	100	115

cilinders

hand- en mechanisch
bediende ventielen

elektrisch bediende
ventielen

luchtbediende
ventielen

magneetventielen

luchtbediende
schuine klepafsluiters

luchtverzorging

hulpventielen

aansluitmateriaal

Any questions? Please contact us.

